

## Ultrasonic Water Meter

Model: LXC-50H-500H



## User manual

## Table of contents

1. Overview .....	03
2. Implementation standard of this product .....	03
3. Technology parameters .....	04
4. Outline dimension .....	05
5. Nameplate .....	06
6. Operation and display .....	07
6.1 Operation .....	07
6.2 Display .....	07
7. Rated operation conditions .....	12
8. Actively report the abnormal information of the meter .....	12
9. Installation and connection .....	13
9.1 Installation and Connection Requirements .....	13
9.2 Instrument Installation Position .....	13
9.3 Installation method .....	13
10. Troubleshooting .....	14
11. Transportation and storage .....	14
12. Warranty terms .....	14
13. After-sales services .....	15

# 1. Overview

The working principle of the LXC-50H-500H ultrasonic water meter is to measure the flow rate using ultrasonic time difference method. That is an ultrasonic transducer is installed upstream and downstream of the measurement channel (pipe section) for mutual transmission and reception of ultrasonic signals. Since the ultrasonic signal is superimposed with the water flow signal, the propagation speed of the sound wave during the downstream and counter current is different, the running time of the ultrasonic signal emitted by different transducers in water is different. By measuring the difference in this time, the flow rate of the fluid can be calculated, and then converted into flow rate, thereby realizing the measurement of flow rate. The meter integrates measurement, calculation and display. It uses micro-power technology. A battery can be used for 10 years and we use ER26500 default, if you have special requirement we can change it to ER34615 use 15 years. At the same time, the meter has the characteristics of small size, high stability and strong anti-interference ability.

- Ultrasound flow measurement technology is used to achieve multi-angle installation that doesn't affect the meter accuracy, nor the system pressure loss.
- The water meters can be equipped with the following communication interfaces:  
Optical interface, LoRaWAN, LoRa RF, M-BUS, RS-485, wM-Bus, NB-IoT, 4G(CAT-1), Pulse output, Sigfox.
- Mainly used for household measurement of residential quarters.

# 2. Implementation Standards

Our water meters are designed and manufactured in compliance with the following international standards and certifications:

**MID (2014/32/EU):** Certified for use in custody transfer and billing applications within the European Union, ensuring measurement accuracy and legal compliance.

**OIML R49:** Conforms to internationally recognized metrological requirements, including maximum permissible errors and durability testing.

**EN 14154:** Meets European standards for water meter mechanical performance, pressure resistance, and flow rate characteristics.

**ISO 4064:** Complies with the international standard for cold potable water meters, covering flow ranges (Q1–Q4), accuracy classes, and long-term stability.

**CE Marking:** Declares conformity with EU directives on safety, electromagnetic compatibility (EMC), and environmental protection.

**NSF (NSF/ANSI 61 & 372):** Complies with standards for drinking water applications, ensuring all wetted materials are non-toxic and meet low-lead requirements.

These standards collectively guarantee reliable performance, measurement integrity, and safety for potable water applications worldwide.

### 3. Technology parameters

Diameter	Overload Q4 (m3/h)	Permanent Q3 (m3/h)	Transitional Q2 (m3/h)	Minimum Q1 (m3/h)
DN50	31.25	25	0.25	0.15625
DN65	50	40	0.4	0.25
DN80	78.75	63	0.63	0.39375
DN100	125	100	1	0.625
DN125	200	160	1.6	1
DN150	312.5	250	2.5	1.5625
DN200	500	400	4	2.5
DN250	787.5	630	6.3	3.9375
DN300	1250	1000	10	6.25
DN350	1750	1400	17.9	11.2
DN400	2000	1600	20.5	12.8
DN450	2500	2000	25.6	16
DN500	3125	2500	32	20
Accuracy class	Class 2			
Range Ratio	R160			
Pressure Loss	$\Delta p_{63}$			
Maximum Working Pressure (MPa)	1.6			
Data Storage	Data storage for continual 48 months			
Power-off Protection	The data of accumulated flow and corresponding time will be saved once power failure takes place, and the meter works automatically as soon as the power restoration.			
Remote Transmission	Optical interface, LoRaWAN, LoRa RF, M-BUS, RS-485, wM-Bus, NB-IoT, 4G(CAT-1), Pulse output, Sigfox.			
Power Supply	Lithium Battery Power Supply			
Protection Class	IP68			
Medium Temperature Range	T50/T90			
Ambient Temperature Range	-20°C...55°C			
Environment	E1, M1, B			
Flow Field Sensitivity	DN50-DN200: U5/D3    DN250-DN500: U10/D5			
Installation	Horizontal or Vertical			
Service Life	Life Timez 10 years			

## 4. Outline dimension

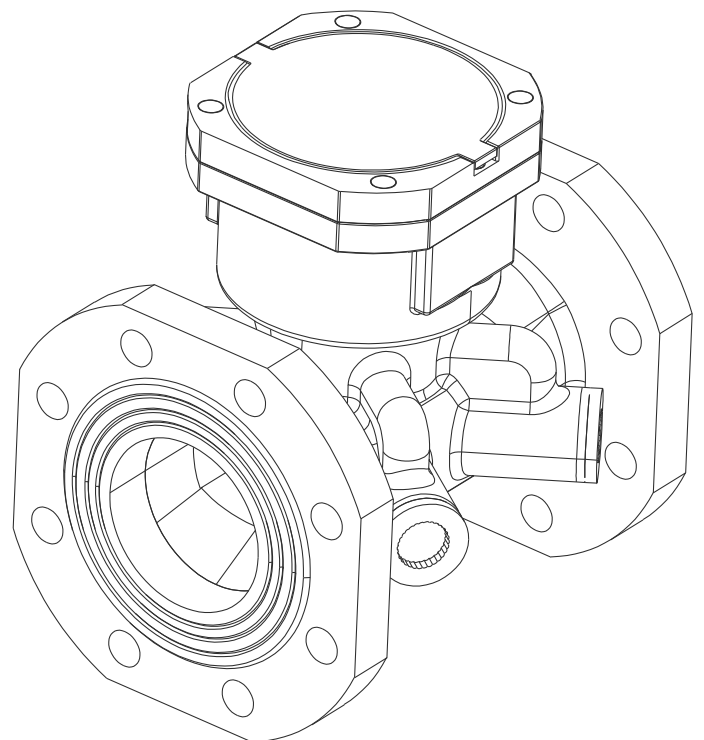
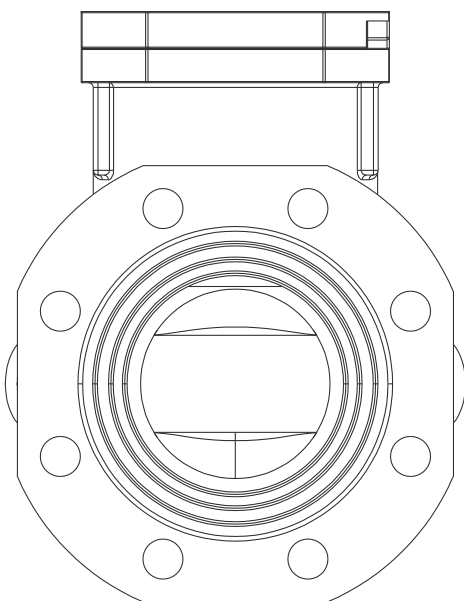
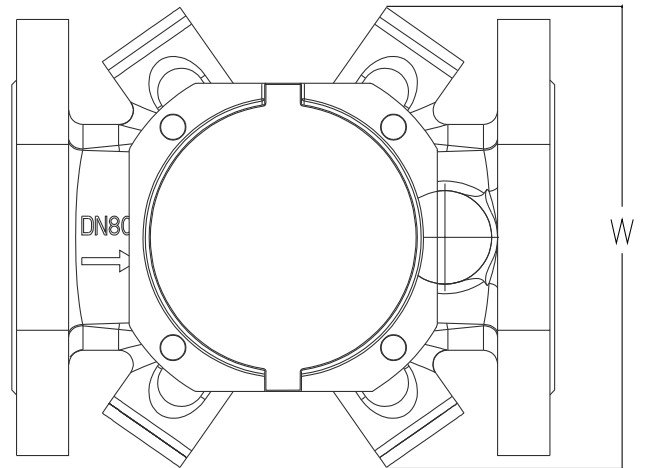
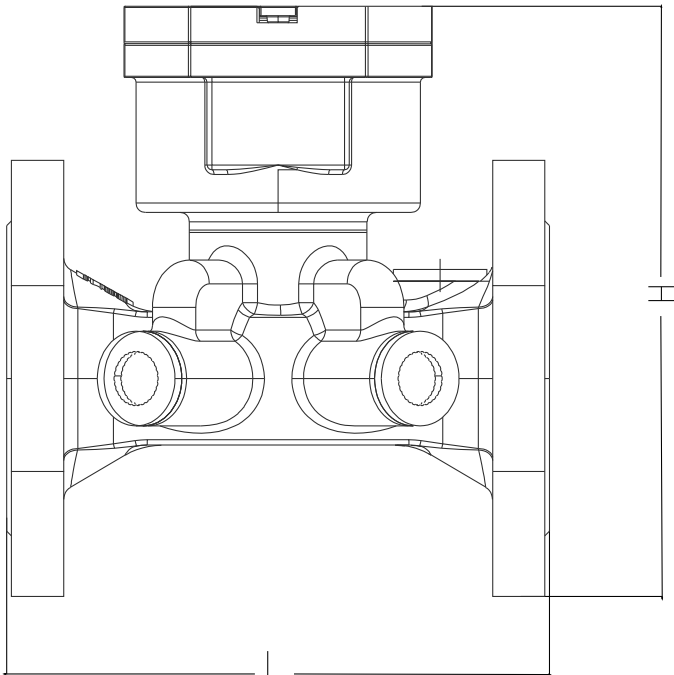

Npminal Diameter(mm)	L(mm)	H(mm)	W(mm)	Md	Bolt Hole Qty
DN50	200	220	170	M16	4
DN65	200	240	185	M16	4
DN80	225	255	250	M16	8
DN100	250	275	270	M16	8
DN125	250	305	300	M16	8
DN150	300	335	330	M20	8
DN200	350	395	380	M20	12
DN250	450	460	415	M24	12
DN300	500	510	470	M24	12
DN350	550	560	520	M24	16
DN400	600	590	580	M27	16
DN450	650	620	640	M27	20
DN500	650	650	705	M30	20

## 5. Panel Design

Example:

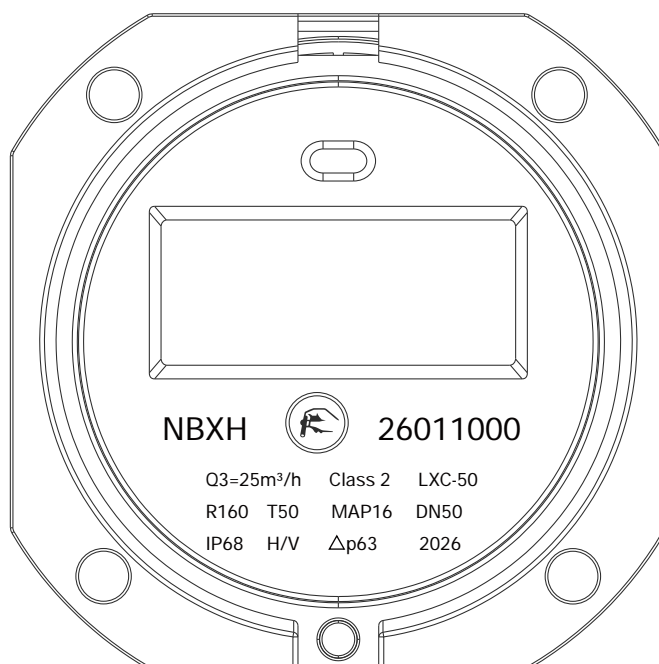

**LXC-50H-500H**

## 6. Operation and display

### 6.1 Operation

6.1.1 Users can use their fingers to touch buttons to switch the display content and view relevant data measured by the instrument. The instrument displays data in a cyclic menu structure.

6.1.2 The LCD display main menu is divided into 5 modes: user mode, calibration mode, information mode, alarm mode and wireless communication. The conversion between five modes, with a key press time > 3s; Switching of menu display in the same mode, key press time < 1s.

6.1.3 In user mode, touch the button to view accumulated volume, flow rate, full screen display, instrument address, accumulated working time, date, specifications, version number, alarm information, and other content.

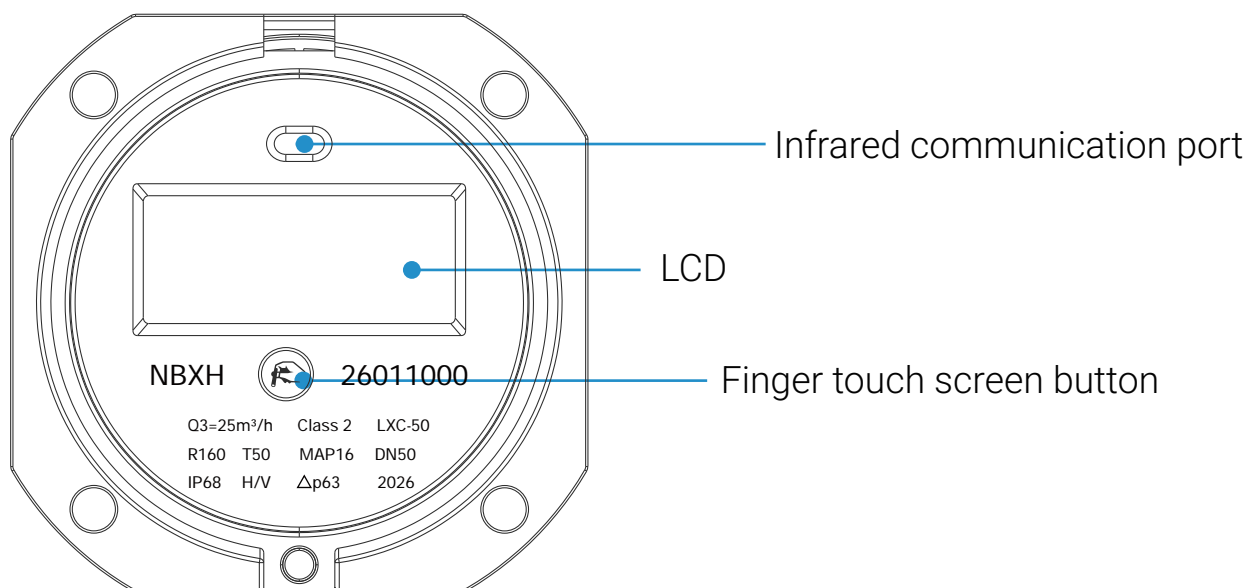





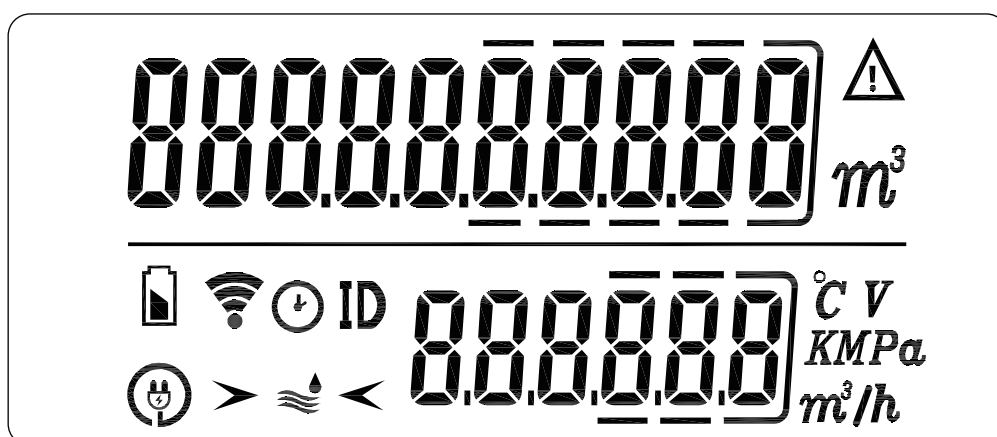



### 6.2 Display





#### 6.2.1 Full screen display



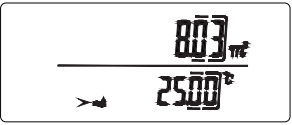
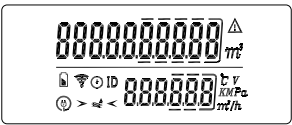

## 6.2.2 Display Icons definition

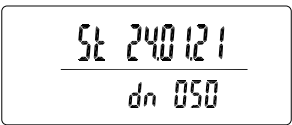
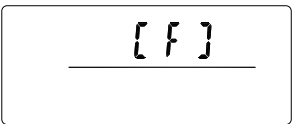
Icons	Definition	Description
	Warning symbol	When an alarm situation occurs, this symbol will appear.
	Low voltage prompt symbol	When this symbol is displayed, it indicates that the battery voltage is below 2.8V and needs to be replaced.
	Wireless communication symbols	When this symbol is displayed, it indicates that the instrument is transmitting data through wireless communication.
	Time symbol	When viewing historical data, this symbol will appear
<b>ID</b>	Water meter number symbol	When this symbol appears, it indicates that the following content is the meter number of this water meter.
	External power supply symbol	When an external power source is connected, this symbol will appear.
	Symbol for forward water flow	When the water flows in the forward direction, this symbol remains illuminated; When there is no water flowing, this symbol flashes.
	Water volume indicator symbol in pipeline	When the pipeline is empty or not fully filled with water, this symbol flashes; When the pipeline is filled with water, this symbol remains illuminated.
	Symbol for reverse flow of water	When there is reverse water flow, this symbol remains illuminated; When there is no water flowing, this symbol flashes.

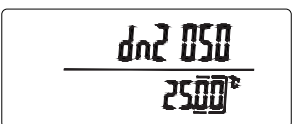
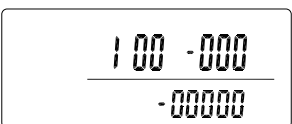
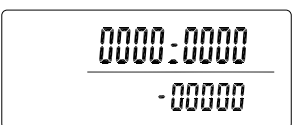
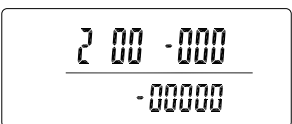
### 6.2.3 Display menu description

Serial Number	Example	Item	Description
1		Positive cumulative volume instantaneous flow rate	The positive cumulative volume of the water meter is 8.03 cubic meters. The instantaneous flow rate indicated by the water meter is 0.000 cubic meters per hour.
2		Positive cumulative volume Water temperature	The positive cumulative volume of the water meter is 8.03 cubic meters. The water temperature displayed on the water meter is 25.00 °C.
3		Full screen display	Display all characters.
4		Water meter serial number Water meter status	The serial number of this water meter is 00000001. The status of this water meter is E 0010.
5		Current date Accumulated working time	The current time displayed on this water meter is "2024.01.08". The cumulative working time of this water meter is 37 hours.
6		Software version number Water meter specifications	The software version number of this water meter is "24.04.21". The specification of this water meter is DN50.
7		Detection menu	Enter the detection menu to test the measuring performance of the water meter.
8		Cumulative volume instantaneous flow rate	The cumulative volume of the water meter is 0.000 L. The instantaneous flow rate indicated by the water meter is 0.000 cubic meters per hour.
9		Water meter specifications Water temperature	The specification of this water meter is DN50. The water temperature displayed on the water meter is 25.00 °C.
10		Initial parameters of channel 1 Time difference	For reference only by technical personnel during debugging.
11		Channel 1 sound path time Time difference	For reference only by technical personnel during debugging.
12		Initial parameters of channel 2 Time difference	For reference only by technical personnel during debugging.

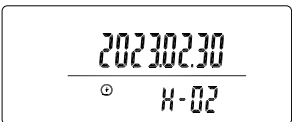
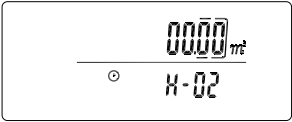
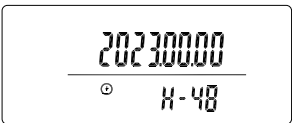
Serial Number	Example	Item	Description
13		Channel 2 sound path time Time difference	For reference only by technical personnel during debugging.
14		Debugging parameters Time difference	For reference only by technical personnel during debugging.
15		Instrument parameters Water meter specifications	The instrument parameters of this water meter is "22000-100". The specification of this water meter is DN50.
16		Pressure sensor interface	Reserve for future use
17		Verify pulse output interface	For reference only by technical personnel during debugging.
18		Information Menu	Enter the information menu to view information on water meter related data.
19		Current volume Current voltage	The current volume of the water meter is 0.03 cubic meters. The current voltage of the water meter is 3.67V.
20		Current date Current time	The current date on the water meter is 01.08.2024. The current time displayed on the water meter is 14:50:08.
21		Measurement parameter 1 Water meter specifications	For reference only by technical personnel during debugging.
22		Instrument address (including manufacturer code)	Address is 000000000000001.
23		MODBUS address protocol parameters	The MODBUS address is 10, and the baud rate is 9600bps.
24		Data storage time for the previous month	The data storage time for the previous month is 01.31.2023.
25		Accumulated volume of the previous month	The cumulative volume of data stored in the previous month was 0.000 cubic meters.

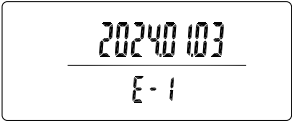
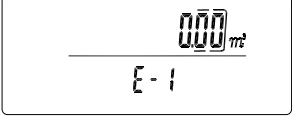
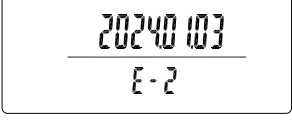
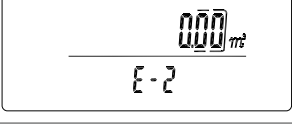
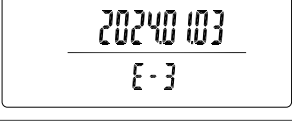
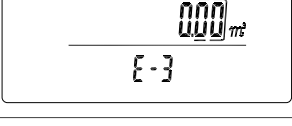
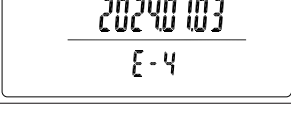
Serial Number	Example	Item	Description
26		Data storage duration for the previous 2 months	The data storage time for the previous 2 months is 02.30.2023.
27		Accumulated volume in the previous 2 months	The cumulative volume of data stored in the previous 2 months was 0.000 cubic meters.
28	.....	.....	.....
29		Data storage duration for the previous 48 months	The data storage time for the previous 48 months is 00.00.2023.
30		Accumulated volume in the previous 48 months	The cumulative volume of data stored in the previous 48 months was 0.000 cubic meters.
31		Error message menu	Enter the error message menu to view the time when the relevant error occurred.
32		Date of undervoltage occurrence	The date of undervoltage occurrence is 01.03.2024.
33		Accumulated volume during undervoltage	The cumulative volume during undervoltage is 0.00 cubic meters.
34		Reverse occurrence date	The reverse occurrence date is 01.03.2024.
35		Cumulative volume during reversal	The cumulative volume during the reverse direction is 0.00 cubic meters.
36		Date of temperature anomaly	The date of the temperature anomaly is 01.03.2024.
37		Accumulated volume during abnormal temperature	The cumulative volume during temperature anomalies is 0.00 cubic meters.
38		Date when the sensor is abnormal	The date when the sensor was abnormal is 01.03.2024.

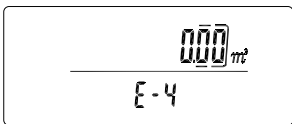
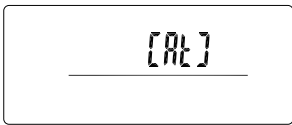
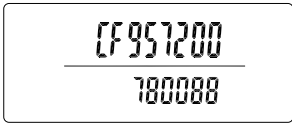
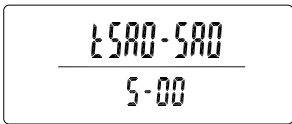
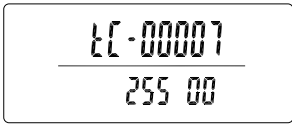
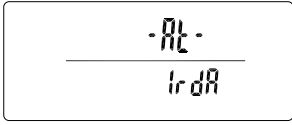
Serial Number	Example	Item	Description
39		Accumulated volume when sensor is abnormal	The cumulative volume when the sensor is abnormal is 0.00 cubic meters.
40		Wireless communication parameter menu	This display indicates that the wireless communication parameter menu has been entered.
41		Parameter DEVEUI	The DEVEUI parameter is: 8CF9572000780088.
42		Sending interval Signal strength	The data upload cycle is 1440 minutes.
43		Number of successes Delivery Status	The number of successful data uploads is 7.
44		Wireless communication settings interface	You can set relevant parameters on this interface.

## 7. Rated operation conditions

Flow range:  $Q_1 \leq Q \leq Q_3$ .

Working environment temperature range:  $-25^{\circ}\text{C} \sim 55^{\circ}\text{C}$ .

Water temperature range:  $0.1^{\circ}\text{C} \sim 50.0^{\circ}\text{C}$ .

Working environment humidity range:  $\leq 93\% \text{RH}$ .

Working pressure range:  $0.03 \text{ MPa} \sim 1.6 \text{ MPa}$ .

## 8. Actively report the abnormal information of the meter

Battery level detection: When the battery is low, the LCD will display , and will report the information to the management system.

Flow detection: When there is no water in the pipeline and no signal in the transducer, the system will report, store error information and alarm.

Flow direction detection: When the water meter is installed in wrong direction, the system will actively report and store the error information and alarm.

## 9. Installation and connection

### 9.1 Installation and Connection Requirements:

Installation should be strictly in accordance to the site professional engineering design, and alteration without engineers permission should be strictly prohibited.

### 9.2 Instrument Installation Position:

- ◆ Installed in vertical pipeline for upward (or oblique upward) flow of liquid, followed by horizontal pipeline, try to avoid downward flow of liquid. (or oblique downward) flowing pipes to prevent liquid from running with the gravity and create air pockets.
- ◆ Installation position should not be selected at the highest point of pipeline direction to prevent abnormal measurement due to bubble accumulation in pipeline.

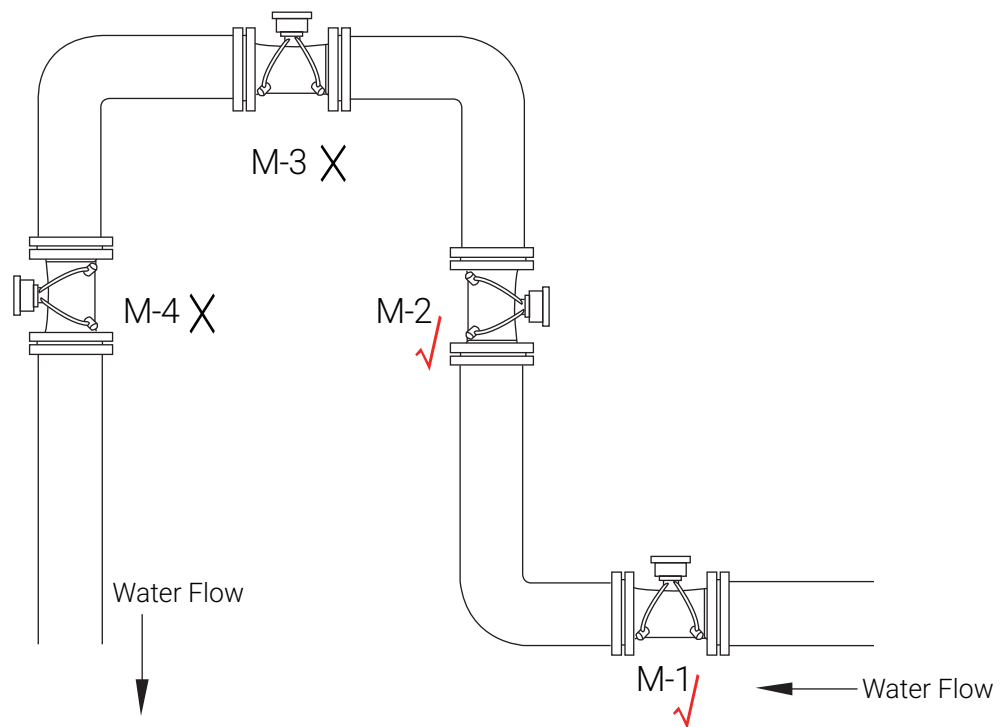

### 9.3 Installation method

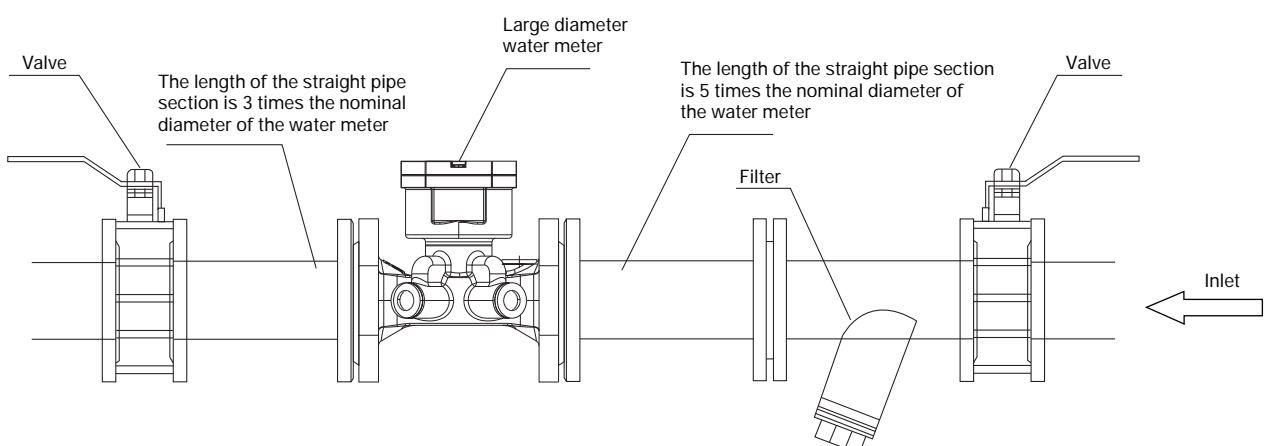

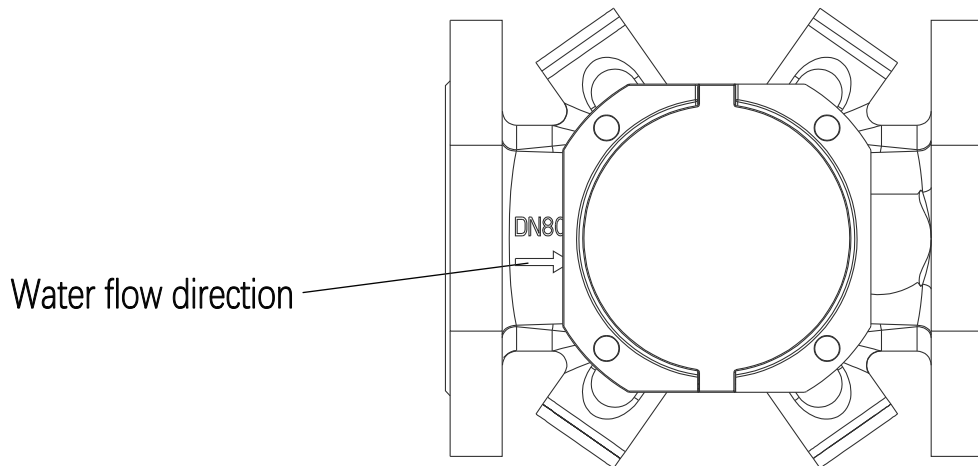

## 10. Troubleshooting

a) The water meter shown as :

This indicates insufficient battery power and requires battery replacement.

b) The water meter is reading negative:

Please check whether the actual water flow direction is consistent with the arrow direction on the water meter.

c) Abnormal or random beating of cold-water meter data:

Possible causes include incorrect installation position, insufficient straight pipe lengths before and after the meter, or an oversized upstream pipe diameter.

## 11. Transportation and storage

11.1. The water meter should be stored in the original package, the ambient temperature is 5-55 C, and the air is free of corrosive gases.

11.2. When water meters are stored on shelves, the stacking height of the boxes should not exceed 1.5 meters.

11.3. During transportation, avoid being squeezed by heavy objects to prevent damage to the water meter.

## 12. Warranty terms

12.1. The warranty period for this water meter is 6 years.

12.2. Within 6 years of using our company's water meter, if the installation is reasonable and the water meter is used under its rated conditions, and if there is any damage or malfunction to the components (excluding freezing damage) caused by manufacturing quality, our company is responsible for repairing or replacing them while maintaining the integrity of the lead seal.

## 13. After-sales services

13.1. Our company provides lifelong after-sales service for water meters.

13.2. When there is a quality problem with the water meter, the user or manager should first provide feedback to the after-sales service department of our company and seek solutions to the problem.

Without the permission of our after-sales service personnel, it is not allowed to damage the lead seal or open the water meter without authorization.

13.3. During the warranty period, if the water meter is damaged or malfunctioning (excluding freezing damage) due to manufacturing quality, our company will be responsible for repairing or replacing it free of charge while maintaining the integrity of the lead seal. After exceeding the warranty period, our company provides paid services.