

Ultrasonic Water Meter

Model: LXC-15B-25B



User manual

Table of contents

1. Overview	03
2. Implementation standard of this product	03
3. Technology parameters	04
4. Outline dimension	05
5. Panel Design	06
6. Accuracy Curve	07
7. Communication mode information	07
8. Operation and display	08
8.1 Operation	08
8.2 Display	09
9. Rated operation conditions	13
10. Actively report the abnormal information of the meter	13
11. Installation and connection	14
11.1 Installation and Connection Requirements	14
11.2 Instrument Installation Position	14
11.3 Installation method	14
12. Troubleshooting	15
13. Transportation and storage	15
14. Warranty terms	15
15. After-sales services	16

1. Overview

The working principle of the LXC-15B-25B ultrasonic water meter is to measure the flow rate using ultrasonic time difference method. That is an ultrasonic transducer is installed upstream and downstream of the measurement channel (pipe section) for mutual transmission and reception of ultrasonic signals. Since the ultrasonic signal is superimposed with the water flow signal, the propagation speed of the sound wave during the downstream and counter current is different, the running time of the ultrasonic signal emitted by different transducers in water is different. By measuring the difference in this time, the flow rate of the fluid can be calculated, and then converted into flow rate, thereby realizing the measurement of flow rate. The meter integrates measurement, calculation and display. It uses micro-power technology. A battery can be used for 10 years and we use ER26500 default, if you have special requirement we can change it to ER34615 use 15 years. At the same time, the meter has the characteristics of small size, high stability and strong anti-interference ability.

- Ultrasound flow measurement technology is used to achieve multi-angle installation that doesn't affect the meter accuracy, nor the system pressure loss.
- The water meters can be equipped with the following communication interfaces:
Optical interface, LoRaWAN, M-BUS, RS-485, wM-Bus, NB-IoT, 4G(CAT-1), Pulse output, Sigfox.
- Mainly used for household measurement of residential quarters.

2. Implementation standard of this product

ISO4064: 2014

GB/T778.1-2018: Measurement of Water Flow in Closed Full Pipelines, Cold Water Meters for Drinking and Hot Water Meters Part 1: Specifications.

GB/T778.2-2018: Water Flow Measurement in Closed Full Pipeline, Requirements for Installation of Drinking Cold Water Meter and Hot Water Meter Part 2.

GB/T778.3-2018: Measurement of Water Flow in Closed Full Pipelines, Test Methods and Equipment for Drinking Cold Water Meters and Hot Water Meters Part 3.

Ex-factory verification is based on the National Metrological Verification Regulation of the People's Republic of China "JJG 162-2019 Verification Regulation of Cold-Water Meters" standard.

3. Technology parameters

	DN15	DN20	DN25
Q4(m ³ /h)	3.125	5.0	7.875
Q3(m ³ /h)	2.5	4.0	6.3
Q2(m ³ /h)	0.016	0.0256	0.040
Q1(m ³ /h)	0.010	0.016	0.0252
Start Flow Rate m ³ /h	0.003	0.005	0.005
Dynamic Range	R250		
Standard	ISO4064 / OIML R49		
Measured Medium	Water		
Metrological Class	Class 2		
Battery	3.6V, Lithium-battery	ER26500(Default) / ER34615	
Battery Life	≥10 Years		
Consumption	<0.2mW		
Pressure Loss	Δp40		
EMC	E1		
Environmental Classification	Class B		
Protection Class	IP68		
Medium Temperature	T50		
Storage Temperature	-25~55 C		
MAP	PN16		
Accuracy	±5% in Range Q1≤Q<Q2		
	±2% in Range Q2≤Q<Q4		
Material	Composite Material		
The Installation Sensitivity	U0/D0		
Climatic and Mechanical	M1		
Key-press	Touch Control Technology		
Display	LCD 9 digit + Prompt		
Menu Contents	Instantaneous flow (m ³ /h), cumulative flow (m ³), screen detection, table address, cumulative working time (h), date (year/month/day), caliber, software version		
Display Range	Total flow: 0m ³ ~ +99999.9999m ³		
Communication	Optical interface, LoRaWAN, M-BUS, RS-485, wM-Bus, NB-IoT, 4G(CAT-1), Pulse output, Sigfox.		
Display and Indication	Unit: L/m ³ /Gal (Optional)		
Data Storage	84 Months		

4. Outline dimension

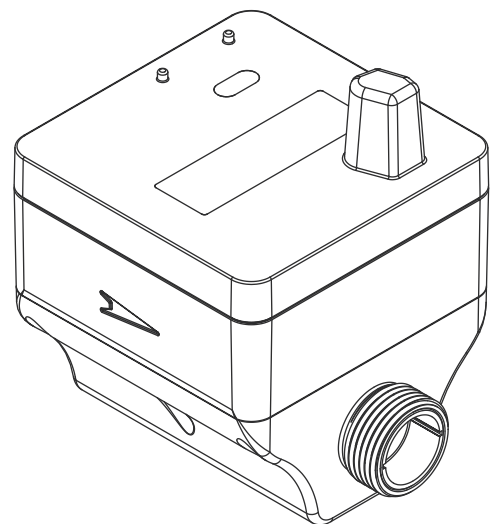
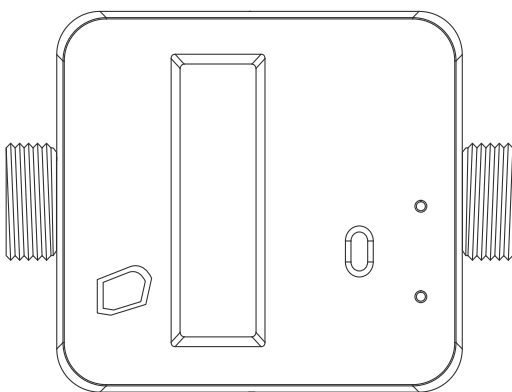
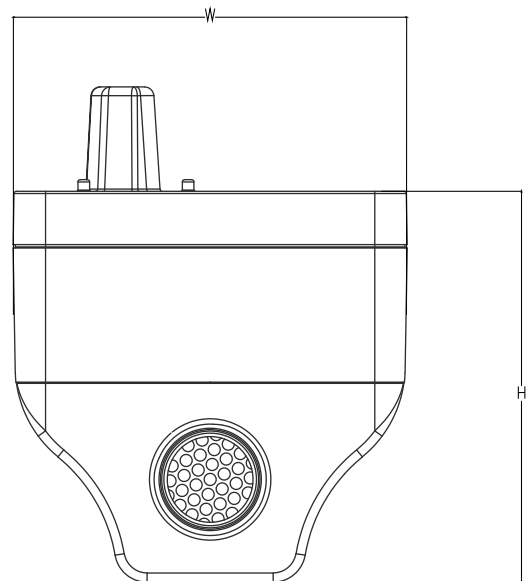
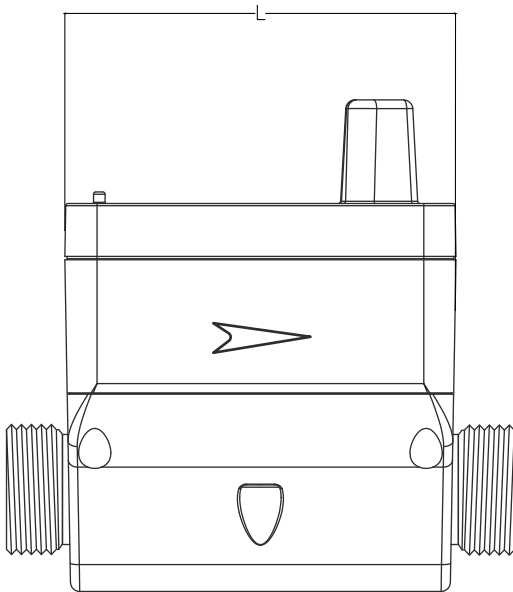

Nominal Diameter (mm)	DN15	DN20	DN25
Thread	G $\frac{3}{4}$ B	G1B	G1 $\frac{1}{4}$ B
L (mm)	110	130	160
H (mm)	80	85	90
W (mm)	85	85	85

5. Panel Design

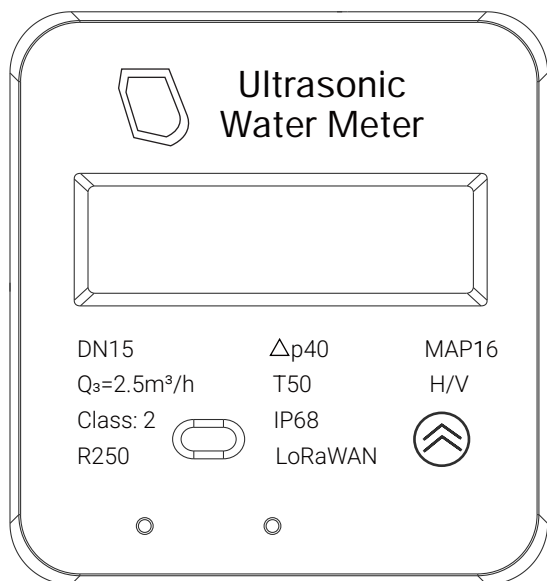

LXC-15B



LXC-20B



LXC-25B

6. Accuracy Curve

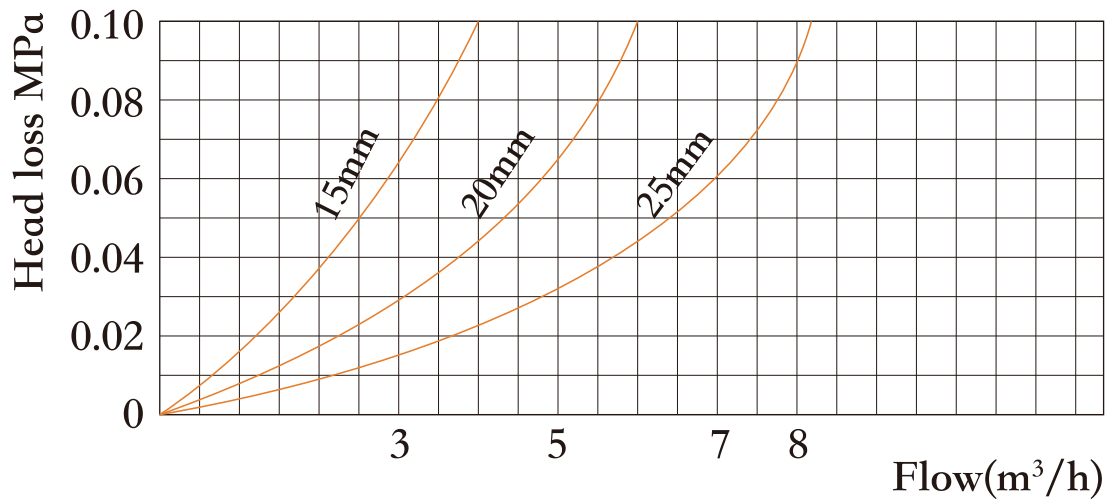
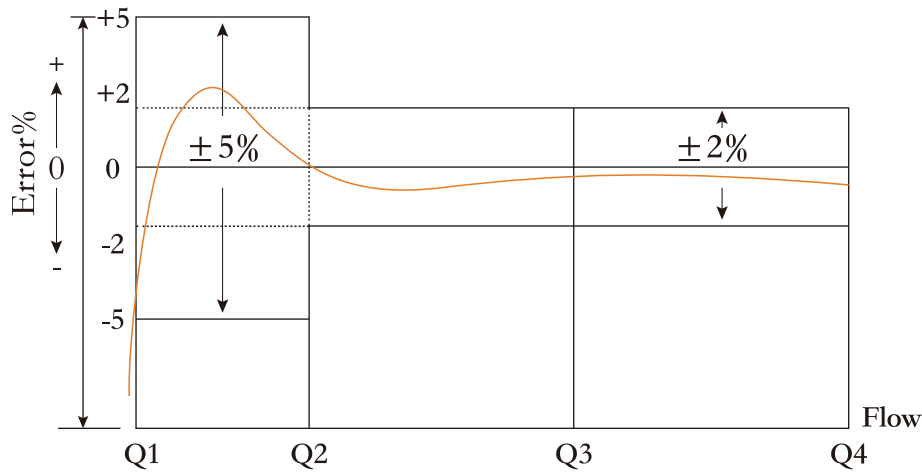

7. Communication mode information:

Pulse Parameters

7.1. Pulse Width: $t_1=500\mu s$, $t_2 \geq 500\mu s$

Or Pulse Width: 125 milliseconds for option, Pulse width customization

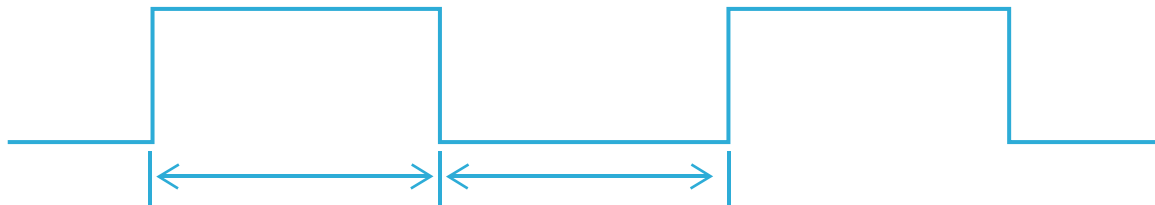

7.2. Pulse Equivalent: 10 L/Pulse

7.3. The yellow cable is Signal, the blue cable is GND (there are sticky notes on the lines)

8. Operation and display

8.1 Operation

8.1.1 Users can use their fingers to touch buttons to switch the display content and view relevant data measured by the instrument. The instrument displays data in a cyclic menu structure.

8.1.2 The LCD display main menu is divided into 4 modes: user mode, calibration mode, information mode and alarm mode. The conversion between four modes, with a key press time > 3s; Switching of menu display in the same mode, key press time < 1s.

8.1.3 In user mode, touch the button to view accumulated volume, flow rate, full screen display, instrument address, accumulated working time, date, specifications, version number, alarm information, and other content.

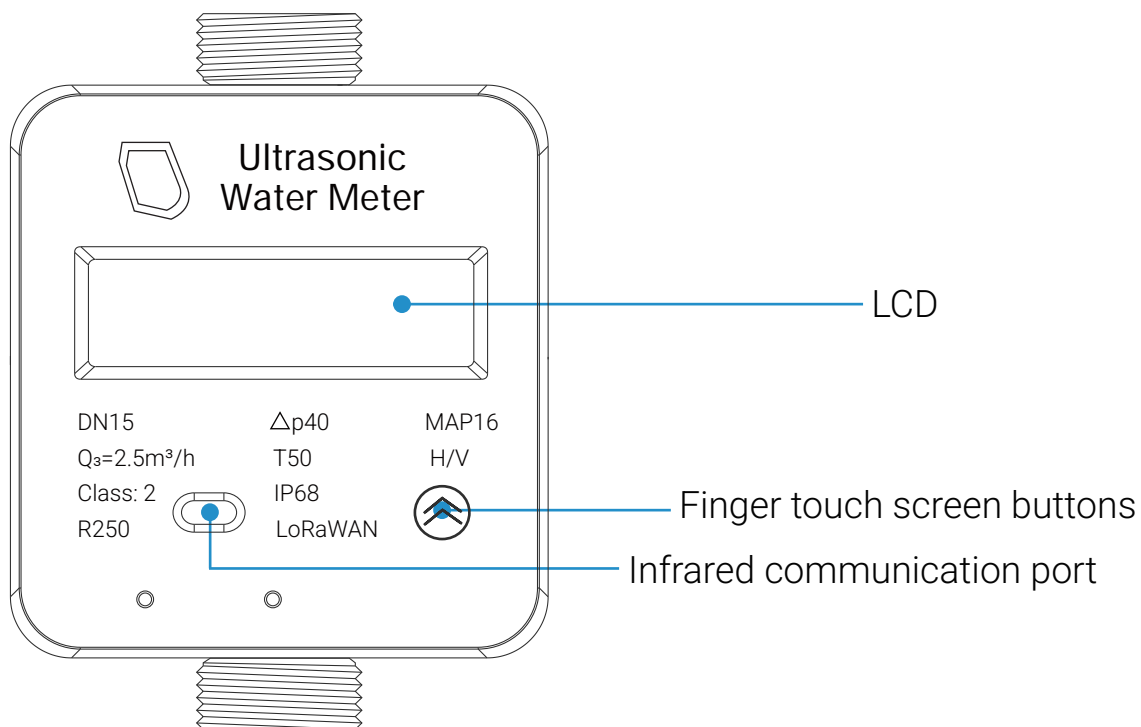





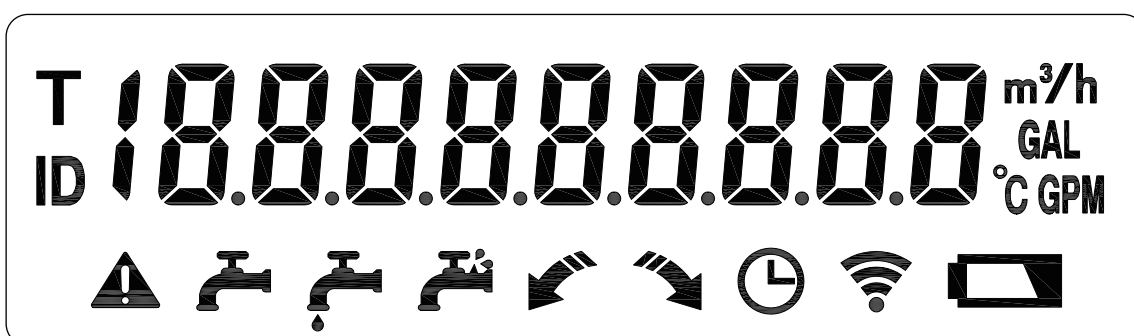



8.2 Display











8.2.1 Full screen display



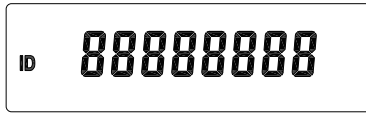

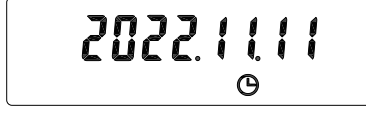

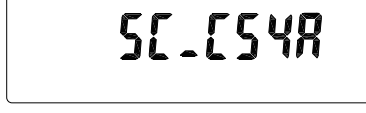







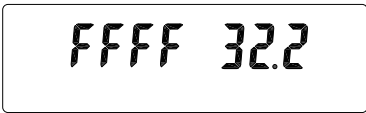

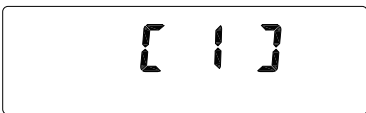
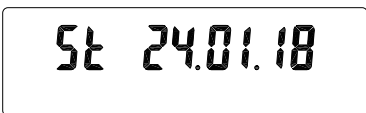

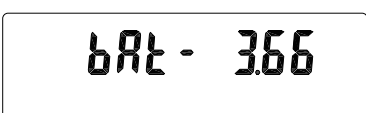
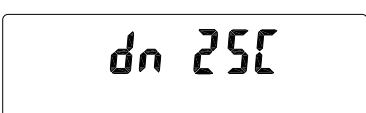





8.2.2 Display Icons definition



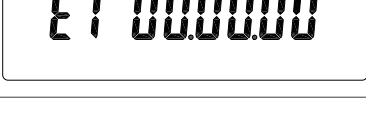
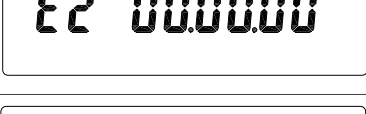

Icons	Definition	Description
T	Detection mode flag	When this flag appears, it indicates that the water meter is currently in detection mode.
ID	Water meter number symbol	When this symbol appears, it indicates that the following content is the meter number of this water meter.
	Fault prompt symbol	When the pipeline leaks, bursts, or the battery is under voltage, this prompt symbol appears.
	Water flow status symbol	When this symbol flashes, it indicates that the water flow has stopped. When this symbol is constantly on, it indicates that the water flow is passing through the water meter in the correct direction.
	Pipeline leakage warning symbol	When this symbol is displayed, it indicates that the water meter has been continuously measuring for more than 16 hours, causing a leak in the pipeline.
	Pipeline burst warning symbol	When this symbol is displayed, it indicates that the flow rate of the water is greater than 200L/h, and the water meter continuously measures for more than 2 hours at this flow rate.
	Reverse flow symbol	When this symbol flashes, it indicates that the water flow is passing through the water meter in the wrong direction.
	Downstream symbol	When this symbol is constantly on, it indicates that the water flow is passing through the water meter in the correct direction; When this symbol flashes, it indicates that the water meter pipe is empty or the water flow has stopped flowing.
	Time reminder symbol	When this symbol appears, it indicates that the time is displayed on the menu.
	Wireless communication symbols	When this symbol is displayed, it indicates that the instrument is transmitting data through wireless communication.
	Low voltage prompt symbol	When this symbol is displayed, it indicates that the battery voltage is below 2.8V and needs to be replaced.

8.2.3 Display menu description

Serial Number	Example	Item	Description
1		Accumulated volume	The positive cumulative volume of the water meter is 65.3970 cubic meters.
2		Reverse cumulative volume	The reverse cumulative volume is 0.088 cubic meters.
3		Current flow rate	The current flow rate is 0.000 cubic meters per hour.
4		Full screen display	Display all characters.
5		Water meter serial number	The serial number of this water meter is 88888888.
6		Accumulated working time	The cumulative working time of this water meter is 45 hours.
7		Current time	The current time displayed on the water meter is November 11, 2022.
8		Water meter specifications	The specification of this water meter is DN25.
9		Software version number	The software version number of this water meter is "24.01.18".
10		Software checksum	The software checksum of this water meter is "C54A".
11		Error code	Display the fault status of this water meter.
12		Detection menu	Enter the detection menu to test the measuring performance of the water meter.

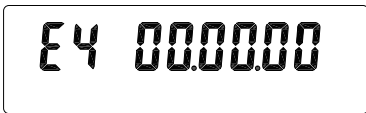
Serial Number	Example	Item	Description
13		Accumulated volume in test state	Accumulated volume of water meter in retest state.
14		Real time flow rate under testing conditions	Real-time flow rate of water meter in testing state.
15		Time difference of ultrasonic transducer	The time difference of ultrasonic waves when the water flow is stationary, For reference by technical personnel during debugging.
16		Time difference in downstream flow	The time difference of ultrasonic waves when the water flows downstream, for reference by technical personnel during debugging.
17		Reverse flow time difference	The time difference of ultrasonic waves when the water flow is reversed, For reference by technical personnel during debugging.
18		Temperature inside the pipeline	The temperature inside the water meter pipeline is 32.2 degrees Celsius.
19		Debugging interface	For reference by technical personnel during debugging.
20		Information Menu	Enter the information menu to view information on water meter related data.
21		Software version number	The software version number of this water meter is "24.01.18".
22		Real time time	The real-time time displayed on the water meter is 13:01:11.
23		Battery voltage	The battery voltage of this water meter is 3.66 V.
24		Water meter specifications	The specification of this water meter is DN25.
25		The top six digits of the address	The top six digits of the communication address for this water meter are 000000.

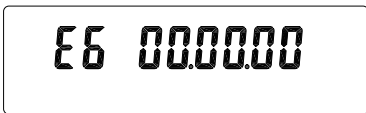
Serial Number	Example	Item	Description
26		The lower 8 digits of the address	The lower 8 digits of the communication address for this water meter are 88888888.
27		Data storage days in the first month	The data storage time for the first month is on the 79th day.
28		Data storage date of the previous month	The data storage date for the first month is May 31st, 25 years.
29		Accumulated volume of data storage in the previous month	The cumulative volume of data stored in the first month is 3.0888 cubic meters.
30		Data storage days in the first 2 months	The data storage time for the first 2 months is on the 48th day.
31		Data storage date of the previous month	The data storage date for the first 2 months is April 30, 2025.
32		Accumulated volume of data storage in the first 2 months	The cumulative volume of data storage in the first 2 months is 3.0888 cubic meters.
33		Data storage days in the first 3 months	The data storage days for the first 3 months are 18 days.
34		Data storage date for the first 3 months	The data storage date for the first 3 months: March 31, 2025.
35		Error message menu	Enter the error message menu to view the time when the relevant error occurred.
36		Time of low voltage occurrence	The time when low voltage appeared was XX year XX month XX day.
37		Time of reverse flow occurrence	The time when the reverse flow occurred is XX year XX month XX day.
38		Time of overload flow occurrence	The time when the overload flow occurred was XX year XX month XX day.

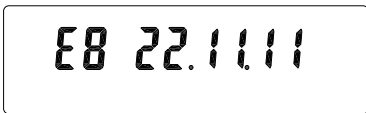
Serial Number	Example	Item	Description
39		Time of leakage occurrence	The leakage occurred on XX year, XX month, XX day.
40		Time of tube explosion	The time of the tube explosion was XX year XX month XX day.
41		Time of temperature anomaly occurrence	The temperature anomaly occurred on XX year, XX month, XX day.
42		Time of abnormal occurrence of flow sensor	The abnormal occurrence time of the flow sensor is XX year XX month XX day.
43		The time when the pipeline is not filled with water	The time when the pipeline was not filled with water was November 11, 2022.

9. Rated operation conditions

Flow range: $Q_1 \leq Q \leq Q_3$.

Working environment temperature range: $-25\text{ }^\circ\text{C} \sim 55\text{ }^\circ\text{C}$.

Water temperature range: $0.1\text{ }^\circ\text{C} \sim 50.0\text{ }^\circ\text{C}$.

Working environment humidity range: $\leq 93\%$ RH.

Working pressure range: $0.03\text{ MPa} \sim 1.6\text{ MPa}$.

10. Actively report the abnormal information of the meter

Battery level detection: When the battery is low, the LCD will display  , and will report the information to the management system.

Flow detection: When there is no water in the pipeline and no signal in the transducer, the system will report, store error information and alarm.

Pipeline leak detection: The flow signal display water running for a long time (such as 24 hours), the system will actively report the error information and alarm.

Pipeline burst detection: The flow signal display large water flow running for a long time (the yield of water and time can be set), the system will actively report and store the error information, and alarm.

Flow direction detection: When the water meter is installed in the wrong direction, the system will actively report and store the error information and alarm.

11. Installation and connection

11.1 Installation and Connection Requirements:

Installation should be strictly in accordance with the site professional engineering design, and alteration without engineers permission should be strictly prohibited.

11.2 Instrument Installation Position:

- ◆ Installed in vertical pipeline for upward (or oblique upward) flow of liquid, followed by horizontal pipeline, try to avoid downward flow of liquid. (or oblique downward) flowing pipes to prevent liquid from running with the gravity and create air pockets.
- ◆ Installation position should not be selected at the highest point of pipeline direction to prevent abnormal measurement due to bubble accumulation in pipeline.

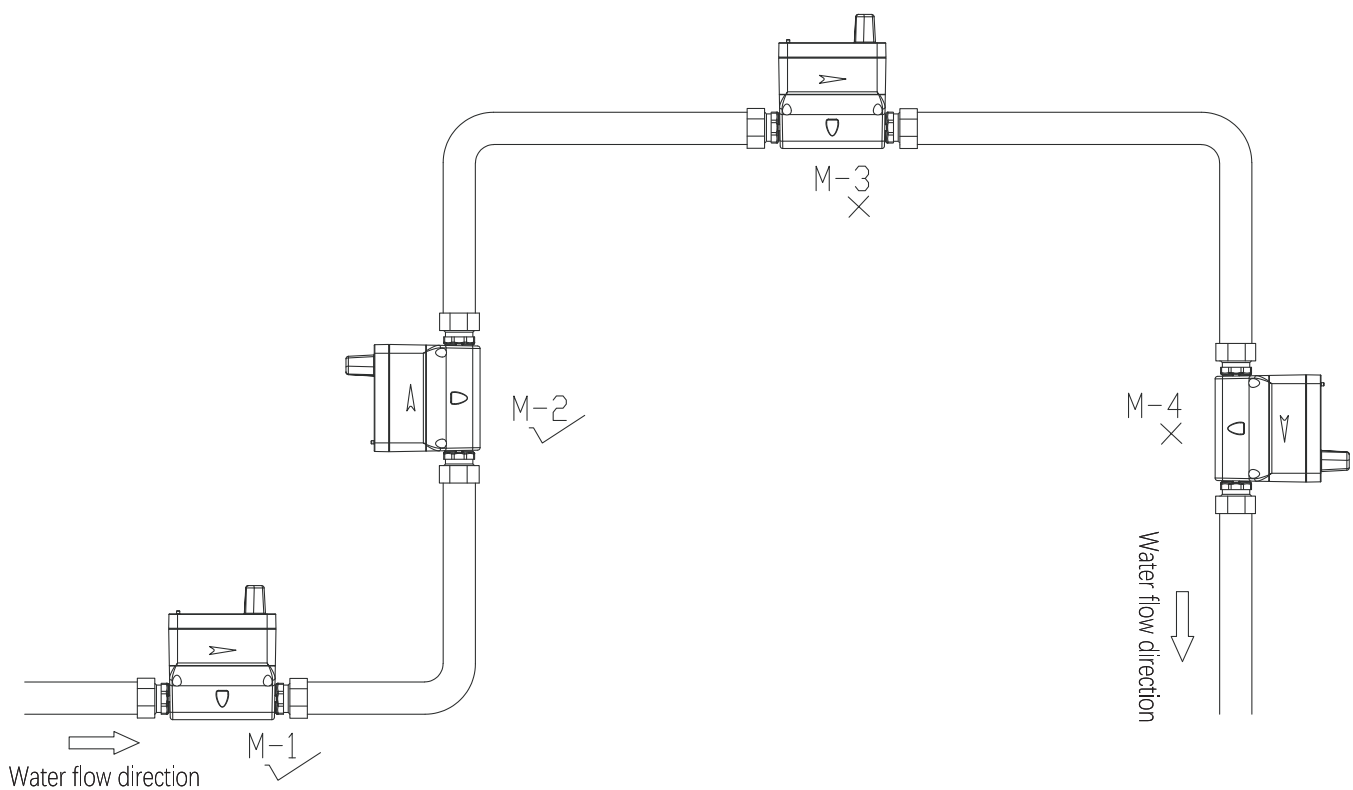

11.3 Installation method

- ◆ Cut off the installation instrument of the water supply pipeline and set aside the location of the installation instrument as shown in the figure.



- ◆ Concentric alignment of instrument.
- ◆ Pipeline and tightening of pipeline blade and instrument thread with the appropriate wrench.
- ◆ Instrument installation completed.

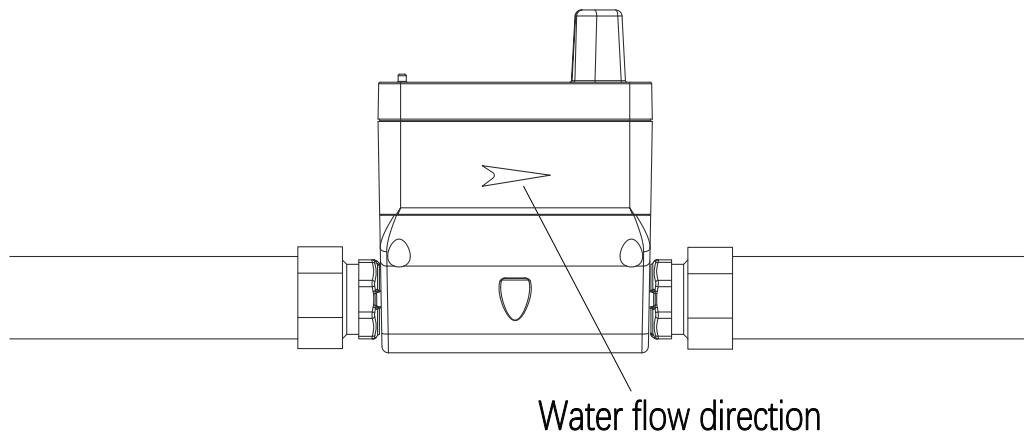

12. Troubleshooting

a) The water meter shown as :

It means that the battery is not enough, this water meter does not support battery replacement. In this case, a new water meter needs to be replaced.

b) The water meter is reading negative:

Check whether the flow direction is reversed. If not, please contact us immediately.

c) Abnormal or random beating of cold-water meter data:

The installation position is incorrect and installed at a lower water level. The front and rear straight section is too short, the bend is too big, and the diameter of the pipe before the table is large.

13. Transportation and storage

13.1. The water meter should be stored in the original package, the ambient temperature is 5-55°C

13.2. When the water meter is stored on the shelf, the stacking height of the boxes should not be more than 5 boxes.

13.3. During transportation, avoid being squeezed by heavy objects to prevent damage to the water meter.

14. Warranty terms

14.1. The warranty period for this water meter is 6 years.

14.2. Within 6 years of using our company's water meter, if the installation is reasonable and the water meter is used under its rated conditions, and if there is any damage or malfunction to the components (excluding freezing damage) caused by manufacturing quality, our company is responsible for repairing or replacing them while maintaining the integrity of the lead seal.

15. After-sales services

15.1. Our company provides lifelong after-sales service for water meters.

15.2. When there is a quality problem with the water meter, the user or manager should first provide feedback to the after-sales service department of our company and seek solutions to the problem.

Without the permission of our after-sales service personnel, it is not allowed to damage the lead seal or open the water meter without authorization.

15.3. During the warranty period, if the water meter is damaged or malfunctioning (excluding freezing damage) due to manufacturing quality, our company will be responsible for repairing or replacing it free of charge while maintaining the integrity of the lead seal. After exceeding the warranty period, our company provides paid services.